

MERRIGAN - SOFA 2 PLAZAS

IMPORTANTE - TENERE PER FUTURE CONSULTAZIONI: LEGGERE ATTENTAMENTE

IMPORTANT - RETAIN FOR FUTURE REFERENCE: READ CAREFULLY

IMPORTANTE - ARCHIVAR LAS INSTRUCCIONES PARA CONSULTARLAS MÁS TARDE: LEA ATENTAMENTE

IMPORTANT - À CONSERVER POUR CONSULTATION ULTERIEURE: LIRE ATTENTIVEMENT

WICHTIG - ZUM SPÄTEREN NACHLESEN AUFBEWAHREN: SORGFÄLTIG DURCHLESEN



10 minutes



INCLUSI
INCLUDED
INCLUIDOS
INCLUS
INBEGRIFFEN

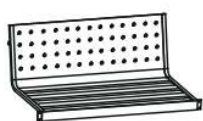

A x1



B-Lx1



B-Rx1



C x1



D x10



M6X15

E x4



M6X10

F x4



G x10



H x1



M6X20

I x2

IT

PRIMA DI PROCEDERE CON IL MONTAGGIO, ASSICURARSI DI POSIZIONARE IL PRODOTTO SU UNA SUPERFICIE PIANA E PULITA E UTILIZZARE UN TELO MORBIDO D'APPOGGIO DURANTE L'ASSEMBLAGGIO. QUESTO PER EVITARE URTI E DANNI AL PRODOTTO DURANTE IL MONTAGGIO. NON STRINGERE LE VITI FINCHE' NON SONO NELLA POSIZIONE CORRETTA.

EN

BEFORE PROCEEDING WITH THE ASSEMBLY, MAKE SURE TO PLACE THE PRODUCT ON A FLAT AND CLEAN SURFACE AND USE A SOFT COVER DURING ASSEMBLY TO AVOID IMPACTS AND DAMAGE TO THE PRODUCT. DON'T TIGHTEN THE SCREWS UNTIL ALL OF THEM ARE IN THE RIGHT POSITION.

ES

ANTES DEL MONTAJE, ASEGÚRESE DE COLOCAR EL PRODUCTO SOBRE UNA SUPERFICIE LIMPIA Y PLANA Y USE UNA TELA SUAVE COMO SOPORTE PARA EVITAR GOLPES Y DAÑOS AL PRODUCTO DURANTE EL MONTAJE. NO APRIETE LOS TORNILLOS HASTA QUE SE ENCUENTREN EN LA POSICIÓN CORRECTA.

FR

AVANT DE PROCÉDER À L'ASSEMBLAGE, ASSUREZ-VOUS DE PLACER LE PRODUIT SUR UNE SURFACE PLANE ET PROPRE ET D'UTILISER UN TISSU SOUPLE DE SUPPORT POUR ÉVITER DES COUPS ET DES DOMMAGES AU PRODUIT PENDANT L'ASSEMBLAGE. NE SERREZ PAS LES VIS JUSQU'À CE QU'ELLES SOIENT TOUTES DANS LA POSITION CORRECTE.

DE

VOR DER MONTAGE BITTE DAS PRODUKT AUF EINE EBENE UND SAUBERE FLÄCHE STELLEN UND EINE WEICHE BAHN FÜR DEN AUFBAU VERWENDEN. DIES DIENT DAZU, STÖSSE UND SCHÄDEN AM PRODUKT WÄHREND DER MONTAGE ZU VERMEIDEN. ZIEHEN SIE DIE STRAUBEN NICHT AN, BIS SIE SICH IN DER RICHTIGEN POSITION BEFINDEN.

1

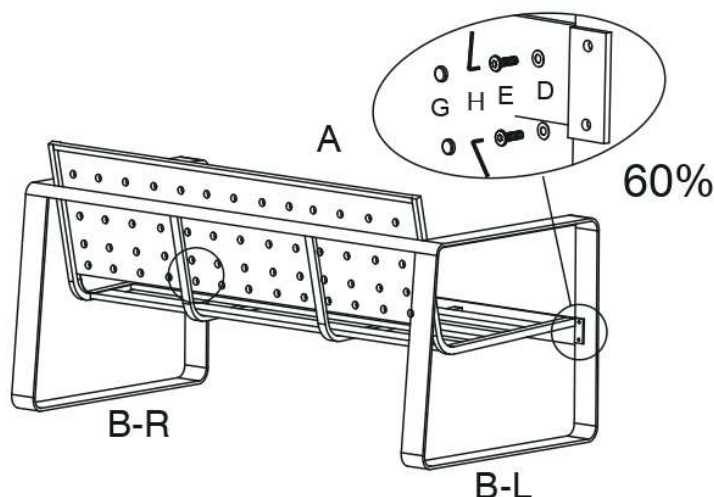

2

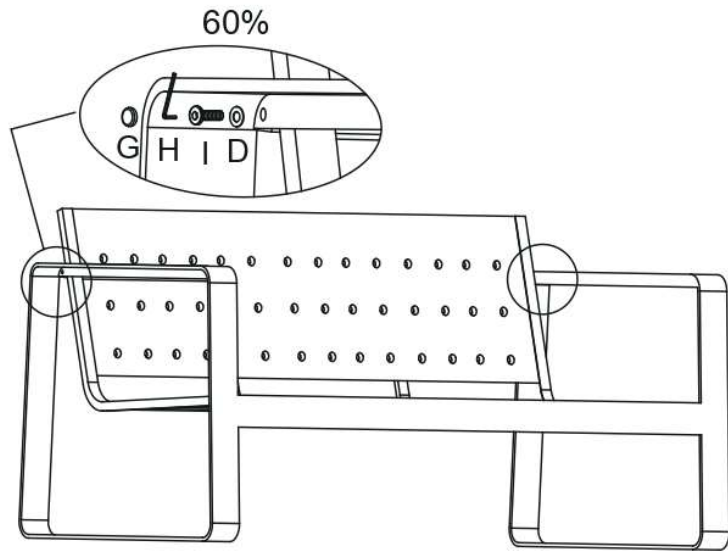

3

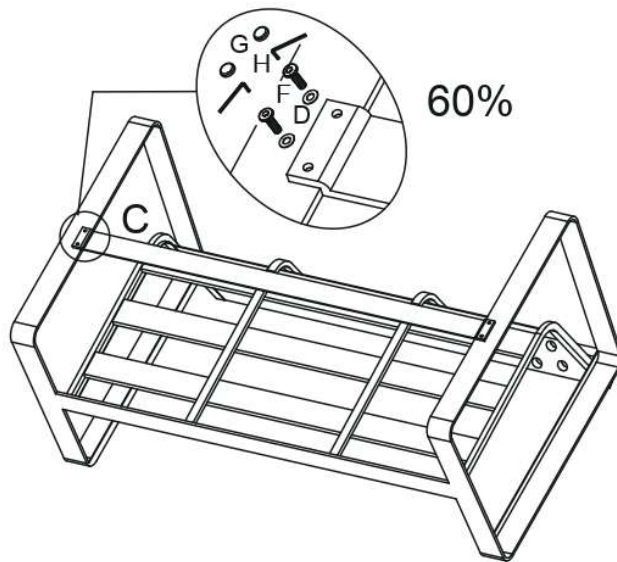

4

