

— ①

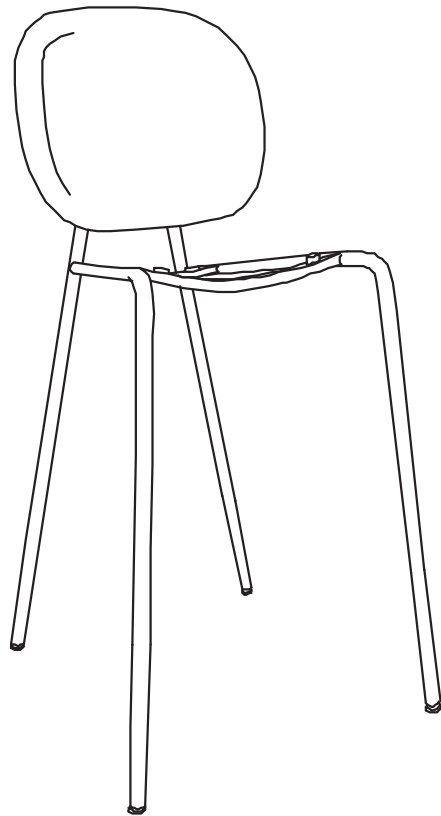

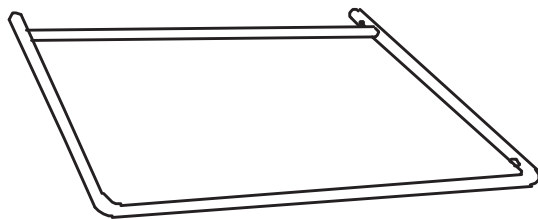

— ②

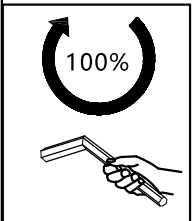

— ③

STEP 1/ ETAPE 1



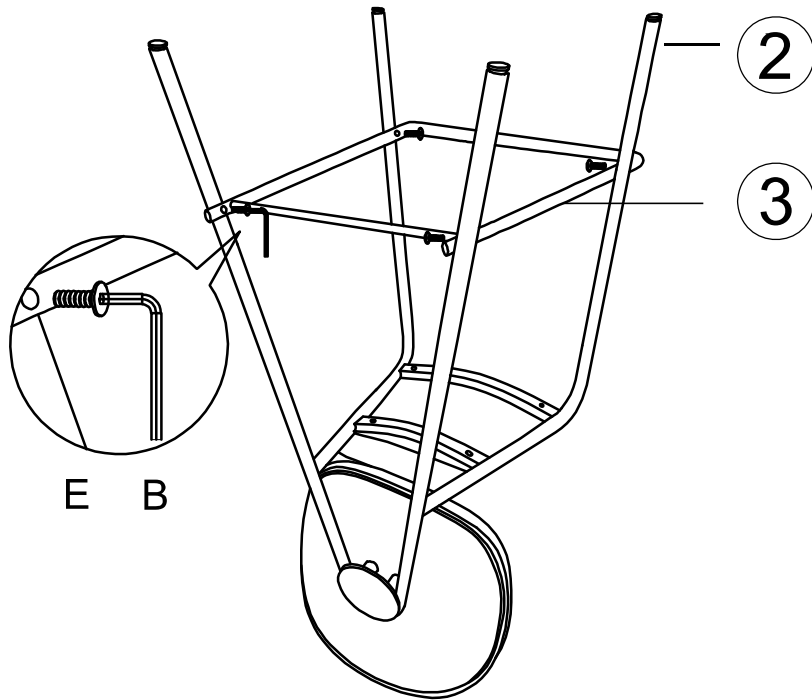

B	 4mm	1 PC
E	 M6x25	4 PCS

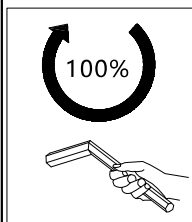

STEP 2/ ETAPE 2



A	 5mm	1 PC
C	 M6x45	4 PCS
D	 6*16*2.0	4 PCS

